

Application technology, 5th edition

Volume III:

Fonterra radiant heating and cooling

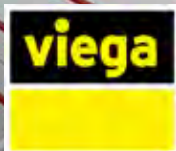

Fonterra Active

General

Fonterra Active was developed specifically for thermal activation of concrete ceilings and for embedding cast-on-site concrete ceilings. In this process, the pipelines conveying the water are integrated in the concrete ceiling to use the concrete mass of the building as a heat accumulator. The target-oriented power of Fonterra Active is perfect for economical heating and cooling as the main load of the cooling and heating requirement can be covered by the radiant heating and cooling; only the hygienic air change must be implemented by means of a cost-intensive ventilation system. Agreeably cool or warm temperatures, depending on the respective situation, improve the efficiency of the persons in the room. The technical implementation does not restrict the architect's and building owner's freedom of design.

In literature, this feature is described as concrete core heating/cooling, concrete core activation, component activation, surface heating/cooling, or thermally activated building systems, so-called TABS.

Operating mode

In building part activation (BPA), the storage capacity of the building mass is used for temperature compensation. By activating the storage mass, the absorbing power of the building part can be used over 24 hours. Thanks to the inertness of the mass, the BPA can operate on a delayed basis, minimising the temperature differences over the course of the day. Even small temperature fluctuations at the building part make high power output possible.

Since water is used as a carrier medium, the energy transport is particularly effective, saving energy and costs. This results in a high energy efficiency in heating and cooling, and ensures maintenance-free operation.

The BPA could be combined with an on-site air conditioning system which would provide for the hygienic air change and support the BPA in case of extreme load fluctuations.

To avoid a reduction of the power of the BPA due to heat transfers, make sure that no closed suspended ceilings or ceilings with acoustic plaster are installed. If sound insulation requirements must be met, they should be implemented by means of sound-optimised furniture and sound-insulated walls.

BPA planning

According to the latest research findings and practical studies, the following points proved to be particularly important for planning building part activations:

- generation of an energy concept including all systems for the entire building
- definition of the energy provision and loading times
- consideration of the users' requirement profiles
- definition of internal temperatures in cooling mode not as fixed values but as adjustable comfort ranges

- provision of high-quality sun protection systems (shading) to minimise the heat input
- definition of the positioning of the pipe registers (on top of the bottom reinforcement up to central layer)
- adjustment of the regulation algorithms to the building

General benefits

- The concrete mass of the building is used as a heat buffer, if applicable over 24 hours.
- Maintenance-free pipelines integrated into the building part are used for high-capacity heating and cooling.
- High energy efficiency, because water and concrete are used as a carrier medium; drafts are avoided.
- If the main load is covered by the radiant heating and cooling system, smaller-sized ventilation and air conditioning systems can be designed, reducing the costs for installing and operating these systems under consideration of the holistic energetic concept.
- The low temperature level makes the use of alternative cold and hot water generation systems possible (take the energy provision times into consideration).
- The size of the installation spaces can be reduced to a minimum since the system is integrated in the building part, resulting in greater design freedom.

Cooling load

The cooling load is the amount of heat to be removed from the room to achieve or maintain a defined room air condition.

According to VDI 2078, one differentiates between the inner and the outer cooling loads.

Outer cooling loads are understood to introduce energy into the building via insolation and warm outside air.

They include:

- heat flow through outer walls
- heat flow through roofs
- transmission heat flow through windows
- radiant heat through windows

Together, these factors are the outer cooling load; its entry into the building must be reduced to a minimum.

The inner cooling loads are cooling loads which result in a heat-up of the room or building due to energy transformation processes.

They include:

- heat emission from persons
- heat emission from lamps
- heat from equipment such as PC, printers, machines, etc.
- heat transmitted from neighbouring rooms

Calculation process

The VDI 2078 offers two different calculation processes, a simple and a detailed one. They are not used to calculate the room cooling load for any point in time but for a special maximum value.

The cooling load of every single room is calculated repeatedly at intervals of one hour on an exemplary day in a particularly hot month (e.g. July 11:00 a.m., 12:00 noon, ... 4:00 p.m., 5:00 p.m. etc.).

To calculate the cooling load of the building, the results of the temperatures of the single rooms measured in hourly intervals are added up (all 11:00 a.m. results of the respective day, all 12:00 noon results, etc. are added up).

The highest of all these results is the cooling load of the building.

Control and manifolds

In cooling mode, so-called comfort ranges should be defined for regulation of the room temperature. The self-regulation effect of thermally active surfaces can be used as a basis; this means that the energy transport is effected automatically because of the existing differences between the temperatures of the room air and of the surfaces. The building should also be divided into different control zones based on utilisation, exposure to insolation, etc. Special attention must be paid to dew point monitoring – in particular of the system components – since they may require diffusion resistant insulation.

In heating mode, an automatic system (control) dependent on the outside temperature is required according to Section 14 of EnEV 2014 to reduce and switch off the heat supply and to switch electrical drives on and off. Furthermore, overheating of the room due to internal loads must be avoided.

Usually, manifolds can be installed at partitions or in suspended ceilings or raised screed floors subject to the subsequent accessibility of the installation site.

Planning

System description

Fonterra Active is intended specifically for use in concrete ceilings (on top of the bottom reinforcement, up to the central layer).

This protected position in the core of the concrete layer ensures maximum freedom of design to meet the architect's or building owner's requirements.

Fonterra Active can

- be adjusted on site to the requirements of the specific building site;
- be flexibly connected to a manifold or a zone valve;
- also be installed in a Tichelmann system with T-pieces.

**Fonterra Active,
construction site
photo**











Fig. 212: Fonterra Active, construction site photo

Features

- Guaranteed drilling depth thanks to mounting of the pipe register on top of the bottom reinforcement or up to the central layer; thus, independent of taboo zones and partitions
- Covering the main load
- Use of oxygen-seal pipes, 17 x 2.0 mm or 20 x 2.0 mm, acc. to DIN 4726
- Connection lines are unthreaded upwards or downwards by means of floor lead-in
- Mounted in the course of formwork or concrete pouring
- Supply lines can be integrated in the regular ceiling construction
- Direct manifold connection possible
- With larger heating circuits, connection can be made by means of T-pieces to a collector pipe laid in the Tichelmann system

System components

Fixing/protection		
		
Floor lead-in element	Pipe guide	Cable tie 200 mm
Pipes		
		
PE-Xc 17x2.0 PE-Xc 20x2.0	PB 17x2.0 PB 20x2.0	Protective pipe for joints 20x28
Accessories		
		
Press connector with SC-Contur 17x2.0 20x2.0	Connection screw fitting with SC-Contur 17x $\frac{3}{4}$ inch 20x $\frac{3}{4}$ inch	T-piece 32/17/32 32/20/32 40/17/40 40/20/40

Name	Article number
Viega pipe shear	652005
Viega press jaw 17	351540
Viega press jaw 20	351557
Press machine, e.g. Pressgun Picco	735470
Protective pipe cutter	446475

**Tools for
BTA 17/20**

Tab. 100: Tools for BTA 17/20

System components

Name	Article number
PB-pipe 17x2.0 240m	697600
PB-pipe 17x2.0 400m	750022
PB-pipe 17x2.0 650m	697617
PB-pipe 20 x2.0 240m	703561
PE-Xc pipe 17x2.0 240m	609627
PE-Xc pipe 17x2.0 400m	750022
PE-Xc pipe 17x2.0 650m	609641
PE-Xc pipe 20x2.0 240m	613631
PE-RT pipe 17x2.0 240m	638813
PE-RT pipe 17x2.0 650m	638320
PE-RT pipe 20x2.0 240m	657345
PE-RT pipe 20x2.0 480m	657352
Protective pipe for joints 20x28	110604
Coupling with SC-Contur 17x2.0	614706
Coupling with SC-Contur 20x2.0	614720
T-piece 32/17/32	656386
32/20/32	656393
40/17/40	656409
40/20/40	656416
Connection screw fitting with SC-Contur 17x $\frac{3}{4}$ inch	614614
Connection screw fitting with SC-Contur 20x $\frac{3}{4}$ inch	614638
Floor lead-in	637095
Pipe guide 17	683702
Pipe guide 20	609504
Cable tie 200 mm	638344

Tab. 101: System components

Technical data Fonterra Active

Technical data

Fonterra Active	BTA 17	BTA 20
max. dimensions per heating/cooling circuit	13 m ²	18 m ²
max. heating areas with Tichelmann system 32/17/32	58 m ²	—
32/20/32	—	65 m ²
40/17/40	85 m ²	—
40/20/40	—	95 m ²
Pipe clearance	15 cm	15 cm
Pipes required	6.5 m/m ²	6.5 m/m ²
max. heating circuit length	90 m*	120 m*
Fixing distance	75 cm	75 cm
Weight of the filled pipe registers	approx. 1.5 kg/m ²	approx. 2.1 kg/m ²

Tab. 102: Technical data

* Connection lines to the manifold must be considered

System pipes		PB 17x2.0	PE-RT 17x2.0	PE-Xc 17x2.0
Dimensions [mm]		17x2.0		
Operating condition acc. to ISO 10508	Class/[MPa]	4/0.6		
Operating condition acc. to ISO 15875-1	Class/[MPa]			4/1
	Class/[MPa]			5/0.8
Operating condition acc. to ISO 22391-1	Class/[MPa]		4/0.6	
Minimum bending radius		5x d _a	6x d _a	5x d _a
Max. operating temperature [°C]		70	70	90
Mounting temperature [°C]		≥ -5	> 5	
Water volume [l/m]		0,13		
Heat conductivity λ [W/(m·K)]		0,22	0,40	0,35
Linear coefficient of length expansion [K ⁻¹]		1.3x10 ⁻⁴	1.8x10 ⁻⁴	2.0x10 ⁻⁴
Weight [g/m]		99	106	102

Technical data system pipes

Tab. 103: Technical data system pipes (Part 1)

System pipes		PB 20x2.0	PE-RT 20x2.0	PE-Xc 20x2.0
Dimensions [mm]		20x2.0		
Operating condition acc. to ISO 10508	Class/[MPa]	4/0.6		
Operating condition acc. to ISO 15875-1	Class/[MPa]			4/0.8
	Class/[MPa]			5/0.6
Operating condition acc. to ISO 22391-1	Class/[MPa]		4/0.6	
Minimum bending radius		5x d _a	6x d _a	5x d _a
Max. operating temperature [°C]		70	70	90
Mounting temperature [°C]		≥ -5	> +5	
Water volume [l/m]		0,20		
Heat conductivity λ [W/(m·K)]		0,22	0,40	0,35
Linear coefficient of length expansion [K ⁻¹]		1.3x10 ⁻⁴	1.8x10 ⁻⁴	2.0x10 ⁻⁴
Weight [g/m]		120	117	118

Tab. 104: Technical data system pipes (Part 2)

Structure

The pipes are placed in the central layer of the concrete ceiling, i.e., depending on the requirements, on top of the bottom reinforcement up to the central layer. This ensures that the drilling depth is guaranteed over the whole of the ceiling/floor area. Depending on the installation situation (e.g. with/without insulation), the heat or cold is released upwards or downwards. The installation in the central layer is independent of taboo zones and partitions and is done just-in-time simultaneously with the formwork or concrete pouring tasks.

Structure

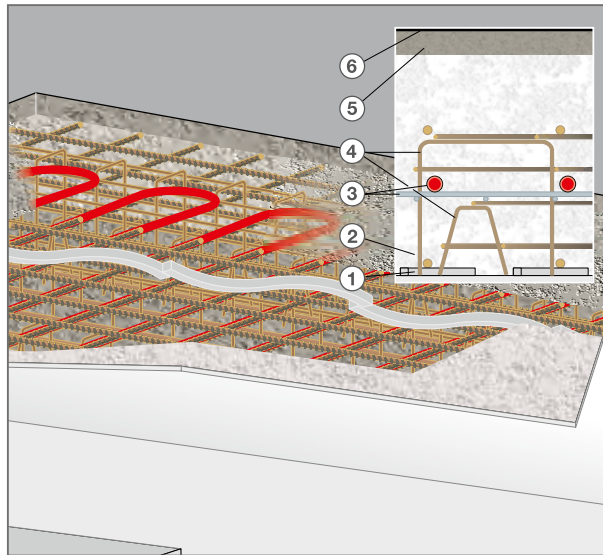

Fig. 213: Structure

Key

- ① Spacer for bottom reinforcement (e.g. fibre cement spacers)
- ② Bottom reinforcement
- ③ Pipe 17/20 mm
- ④ spacer
- ⑤ Top reinforcement
- ⑥ Screed and floor covering

Notes on dimensioning

Material requirement and mounting times

Installation data for Fonterra	Active BTA 17	Active BTA 20
Pipes required	6.5m ²	
Max. register size	13m ²	18m ²
Mounting time in group minutes (on-site manufacture)	approx. 25 to 30 min/m ²	

Tab. 105: Material requirement and mounting times

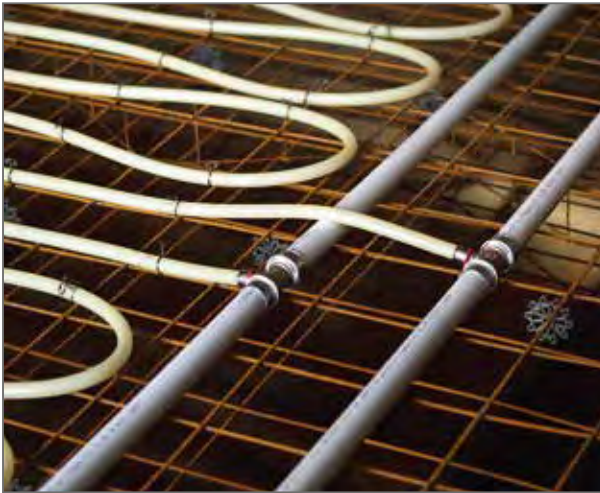

Installation in the Tichelmann system

Fig. 214: Installation in the Tichelmann system



To cover larger system areas as efficiently as possible, Fonterra Active can also be installed in a Tichelmann system. To this end, Sanfix Fosta pipes for heating installations are used as supply lines and controlled by means of a zone valve.

Performance data

Performance of the Fonterra Active with different installation situations

Installation with 25 mm insulation under screed

Operating mode	Heating at 20 °C	Cooling at 26 °C
Supply temperature/return temperature [°C]	29/26	16/19
mean surface temperature ceiling [°C]	approx. 24	approx. 22
mean surface temperature floor [°C]	approx. 21	approx. 25
static performance over ceiling [W/m ²]	approx. 28	approx. 44
static performance over floor [W/m ²]	approx. 6	approx. 6
Total performance of the system [W/m²]	approx. 34	approx. 50

Tab. 106: Installation with 25 mm insulation under screed

Cut with 25 mm insulation

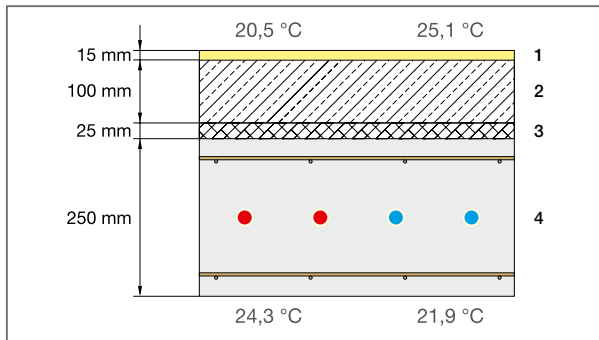

Fig. 215: Cut with 25 mm insulation

Key

- ① Floor covering
- ② Screed
- ③ Insulation
- ④ Concrete

Installation without insulation

Operating mode	Heating at 20 °C	Cooling at 26 °C
Supply temperature/return temperature [°C]	29/26	16/19
mean surface temperature ceiling [°C]	approx. 24	approx. 22
mean surface temperature floor [°C]	approx. 22	approx. 24
static performance over ceiling [W/m ²]	approx. 26	approx. 41
static performance over floor [W/m ²]	approx. 17	approx. 16
Total performance of the system [W/m²]	approx. 43	approx. 57

Tab. 107: Installation without insulation

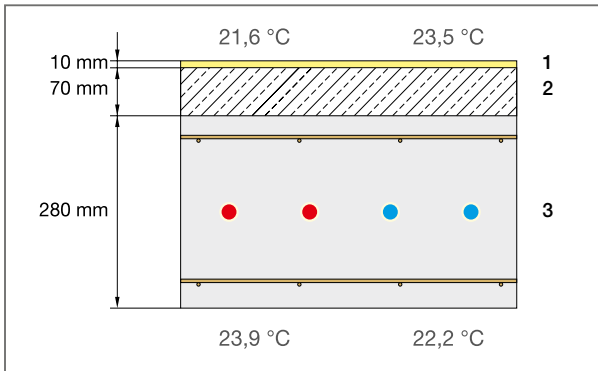

Fig. 216: Cut without insulation

Cut without insulation
Key

- ① Floor covering
- ② Screed
- ③ Concrete

Operating mode	Heating at 20 °C	Cooling at 26 °C
Supply temperature/return temperature [°C]	29/26	16/19
mean surface temperature ceiling [°C]	approx. 24	approx. 22
mean surface temperature floor [°C]	approx. 21	approx. 25
static performance over ceiling [W/m ²]	approx. 28	approx. 44
static performance over floor [W/m ²]	approx. 7	approx. 7
Total performance of the system [W/m ²]	approx. 35	approx. 51

Installation in connection with cavity floor

Tab. 108: Installation in connection with cavity floor

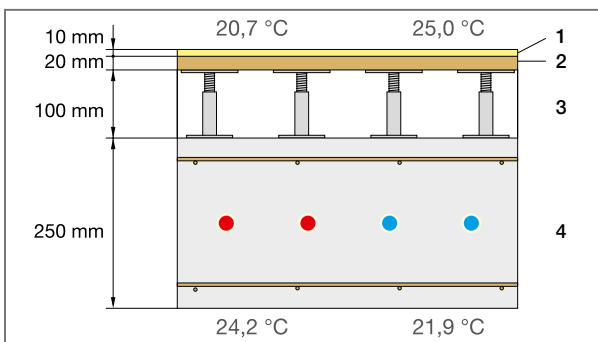

Fig. 217: Cut with cavity floor

Cut with cavity floor
Key

- ① Floor covering
- ② Carrier plate
- ③ Cavity floor
- ④ Concrete

Pressure loss diagram for pipes 17x2.0 and 20x2.0 mm

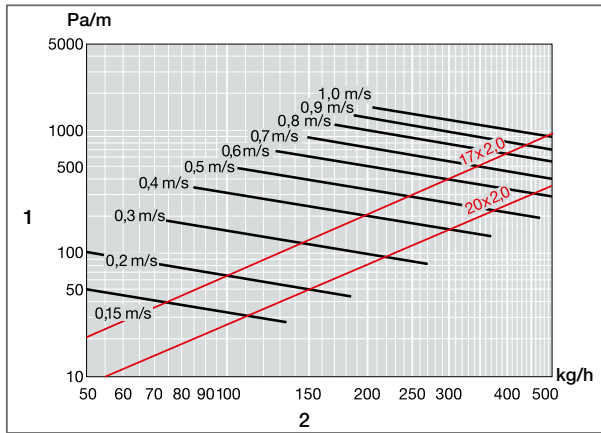

Fig. 218: Pressure loss diagram for Fonterra pipes 17x2.0 and 20x2.0 mm

Key

- ① Pressure gradient R in [Pa/m]
- ② Mass flow m in [kg/h] (fluid: water)

Mounting

Assembly steps

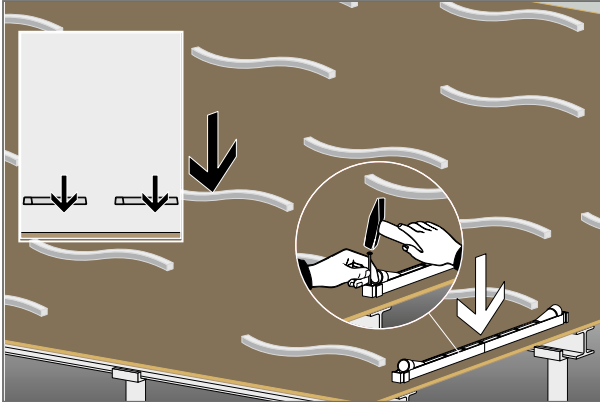

Fig. 219: Mounting of the floor lead-in according to project planning and dimensioning of the on-site spacers for the bottom reinforcement.

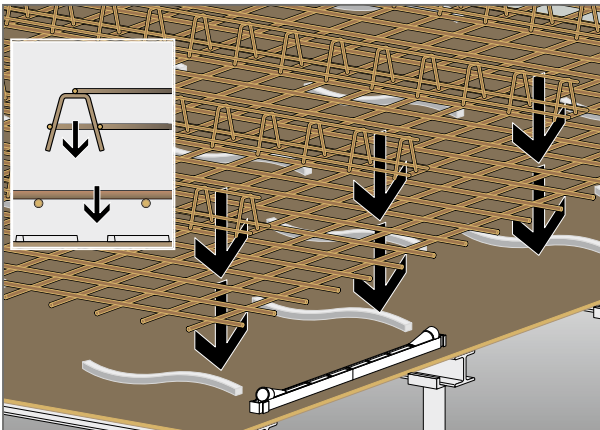

Fig. 220: Dimensioning of the on-site bottom reinforcement according to the specifications from structural analysis.

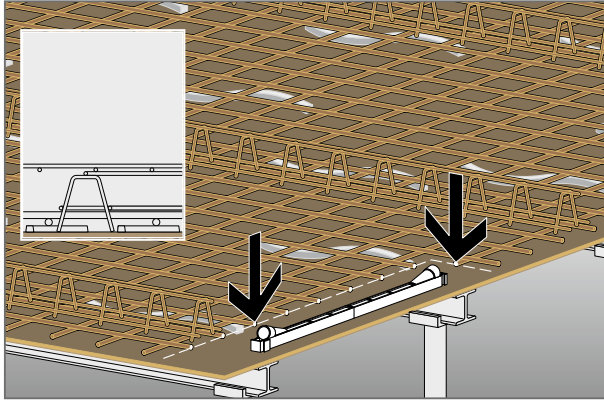

Fig. 221: Dimensioning of the spacers for receiving the pipelines.

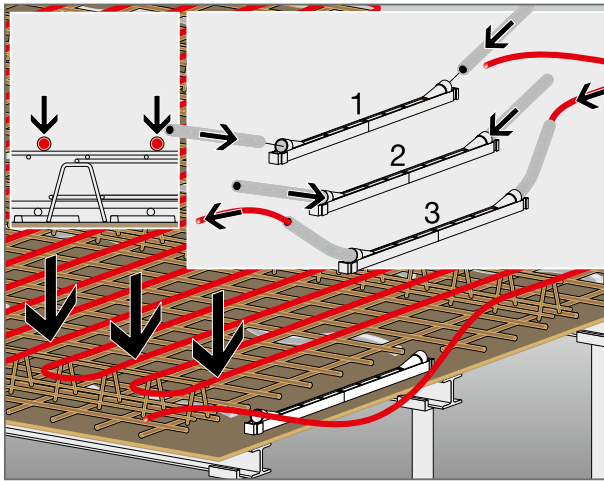

Fig. 222: Installation of the circuits according to project planning and leading the connection pipes through the floor lead-in.

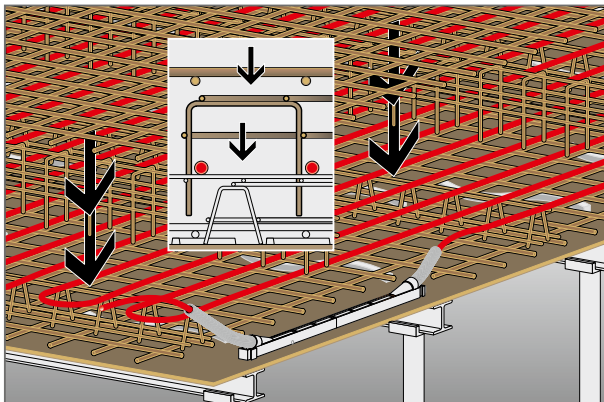

Fig. 223: Dimensioning of the spacers for receiving the top reinforcement.

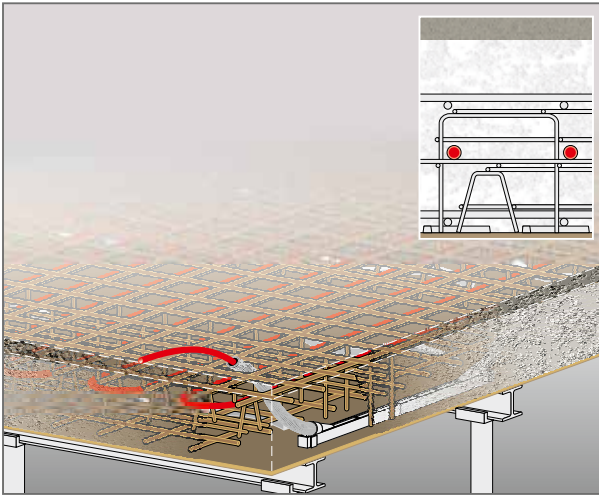

Fig. 224: Dimensioning of the top reinforcement according to the specifications from structural analysis.

Final assembly of the floor lead-in

After stripping the formwork of the ceiling structure, the connection pipes can simply be pulled down from the floor lead-in. To simplify this process for the trade professionals, a tab is provided in the ceiling element which indicates the direction in which the pipe has been pushed in.

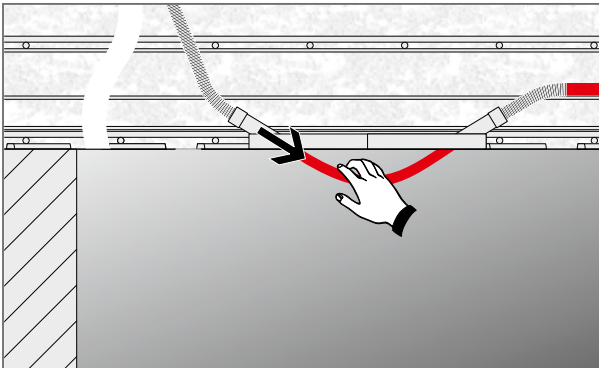

Fig. 225: Pulling the connection pipelines from the floor lead-in.

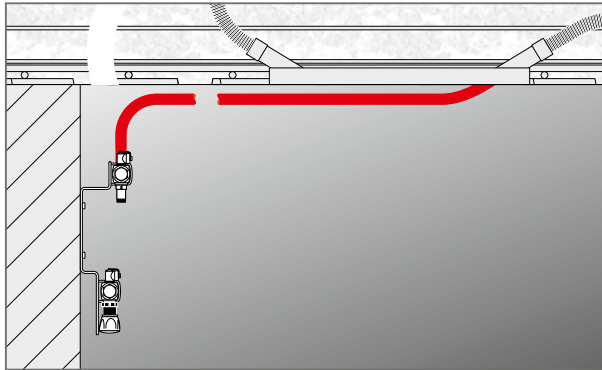

Fig. 226: Connecting the Fonterra Active registers to the manifold, flushing the registers, and commissioning the system after completion of the building shell



During construction, be sure to avoid any deterioration of the fire protection characteristics of the ceiling and the reinforcements in the ceiling; if necessary, additional measures must be taken. To prevent any carry-over of fire and smoke, the remaining empty pipes must be closed up by filling them completely with Viega fire protection putty (model 4920.9). A calcium silicate plate can be put on top as an additional smoke barrier.

Viega recommends to coordinate the design before execution with the person responsible for fire protection and with the approving authority.

Pressure test

Before the start of concrete pouring, the system must be checked for leak tightness according to the pressure test records.

The pressure defined then must be maintained and documented during the whole concrete pouring process.

Handover certificate

This document is handed over to the planner/building owner after completion of the installation work.

Building project		Construction stage Distribution list	
Building owner's address			
Address of the qualified installation company		Date	
Pipe used:	<input type="checkbox"/> PB	<input type="checkbox"/> PE-Xc	<input type="checkbox"/> PE-RT
Pipe dimensions:		<input type="checkbox"/> 17x2.0 mm	<input type="checkbox"/> 20x2.0 mm
Pressure test carried out acc. to pressure test log on:			<input type="checkbox"/> no
Visual inspection of pipe connectors carried out?		<input type="checkbox"/> yes	<input type="checkbox"/> no
Position of couplings marked in the installation plan?		<input type="checkbox"/> yes	<input type="checkbox"/> no
Leak tightness established and documented?		<input type="checkbox"/> yes	<input type="checkbox"/> no
Any leaks were remedied and reported in a separate log.		<input type="checkbox"/> yes	<input type="checkbox"/> no
Installation of the registers acc. to the installation plan	Plan designation:	As at:	
Status of the system on handover	<input type="checkbox"/> System is full (Caution: if not running, system is not frost proof) <input type="checkbox"/> System has been emptied and is frost proof <input type="checkbox"/> System is running <input type="checkbox"/> System is not running		
Comments			
Building owner	Site management	Qualified installation company	
Date/signature/stamp			

Pressure test

This document must be handed over to the planner/building owner after completed pressure test.

We recommend to retain the document.

Building project		Construction stage manifold	
Building owner's address			
Address of the qualified installation company		Date	
<p>Before pouring the concrete, the leak tightness of the heating circuits is tested with water. The leakage test is carried out at the finished but not yet covered pipelines.</p> <p>Notes on the test procedure</p> <ul style="list-style-type: none"> <input type="checkbox"/> Fill the system with filtered water and vent it completely. <input type="checkbox"/> In case of major differences (~10K) between the ambient temperature and the filling water temperature, wait for 30 minutes after filling the system for the temperatures to adjust. <input type="checkbox"/> Carry out the leakage test at a pressure of 0.4 MPa (4 bar), max. 0.6 MPa (6 bar). When handing the subsection over to the subsequent companies and when pouring the concrete, this pressure must be maintained. <input type="checkbox"/> System units not designed for these pressure levels (e.g. safety valves, expansion vessels etc.) must be exempted from the test. <input type="checkbox"/> Visual inspection of the piping system/check per manometer*. <input type="checkbox"/> Take suitable measures to exclude freezing, for example room heating or addition of anti-freeze to the heating water. <input type="checkbox"/> If the anti-freeze is not required for normal operation, the system must be cleaned by emptying and flushing with at least three water exchanges. <input type="checkbox"/> The water temperature must be kept constant during the test. <p>* Pressure gauges must be used which clearly indicate pressure changes of 0.01 MPa.</p>			
Materials used	Pipes:	<input type="checkbox"/> 17x2.0mm	<input type="checkbox"/> 20x2.0mm
	Pipe connectors:	<input type="checkbox"/> Pressing	<input type="checkbox"/> Clamping
Log of the pressure test			
Start of the pressure test:	Start pressure:	Water temperature [°C]:	
End of the pressure test:	Final pressure:	Water temperature [°C]:	
Visual inspection of pipe connectors carried out?	<input type="checkbox"/> yes	<input type="checkbox"/> no	
Position of couplings marked in the installation plan?	<input type="checkbox"/> yes	<input type="checkbox"/> no	
Leak tightness was established, no permanent form changes identified in any component?	<input type="checkbox"/> yes	<input type="checkbox"/> no	
Has the operating pressure been set on system handover?	<input type="checkbox"/> yes	<input type="checkbox"/> no	
Comments			
Building owner	Site management	Qualified installation company	
Date/signature/stamp			

 **Viega Technology GmbH & Co. KG**
Viega Platz 1
57439 Attendorn
Germany

Phone +49 (0) 2722 61-0

viega.com

INT · 709 365 · 2018-05 · VPN 170369

